

SHARP

COMMERCIAL MICROWAVE OVEN

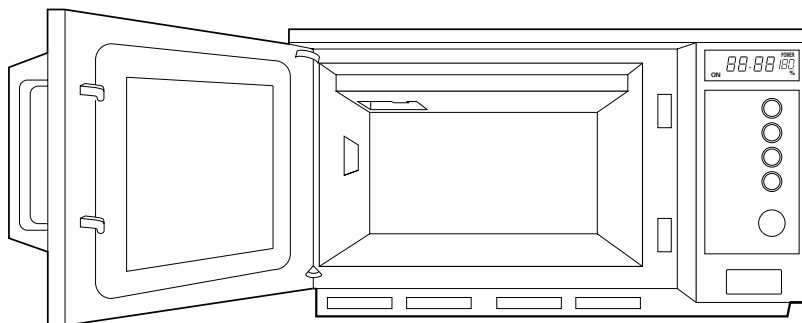

GB

Original Instruction

OPERATION MANUAL - This operation manual contains important information which you should read carefully before using your microwave oven.

IMPORTANT:

There may be a serious risk to health if this operation manual is not followed or if the oven is modified so that it operates with the door open.

R-22AM 1500W (IEC 60705)
R-23AM 1800W (IEC 60705)
R-25AM 2100W (IEC 60705)

GB



Attention:

Your product is marked with this symbol. It means that used electrical and electronic products should not be mixed with general household waste. There is a separate collection system for these products.

A. Information on Disposal for Users (private households)

1. In the European Union

Attention: If you want to dispose of this equipment, please do not use the ordinary dust bin!

Used electrical and electronic equipment must be treated separately and in accordance with legislation that requires proper treatment, recovery and recycling of used electrical and electronic equipment.

Following the implementation by member states, private households within the EU states may return their used electrical and electronic equipment to designated collection facilities free of charge*.

In some countries* your local retailer may also take back your old product free of charge if you purchase a similar new one.

*) Please contact your local authority for further details.

If your used electrical or electronic equipment has batteries or accumulators, please dispose of these separately beforehand according to local requirements.

By disposing of this product correctly you will help ensure that the waste undergoes the necessary treatment, recovery and recycling and thus prevent potential negative effects on the environment and human health which could otherwise arise due to inappropriate waste handling.

2. In other Countries outside the EU

If you wish to discard this product, please contact your local authorities and ask for the correct method of disposal.

For Switzerland: Used electrical or electronic equipment can be returned free of charge to the dealer, even if you don't purchase a new product. Further collection facilities are listed on the homepage of www.swico.ch or www.sens.ch.

B. Information on Disposal for Business Users

1. In the European Union

If the product is used for business purposes and you want to discard it: Please contact your SHARP dealer who will inform you about the take-back of the product. You might be charged for the costs arising from take-back and recycling. Small products (and small amounts) might be taken back by your local collection facilities.

For Spain: Please contact the established collection system or your local authority for take-back of your used products.

2. In other Countries outside the EU

If you wish to discard of this product, please contact your local authorities and ask for the correct method of disposal.

PART NAMES	2, 3	OTHER CONVENIENT FEATURES	5
IMPORTANT SAFETY INSTRUCTIONS	1	CARE AND CLEANING	6
INSTALLATION INSTRUCTIONS	3	SERVICE CALL CHECK	7
ACCESSORIES	3	GUIDE	8
SHORT DESCRIPTION OF FEATURES	4	SPECIFICATIONS	12
BEFORE OPERATION	4	SERVICE PROCEDURE FOR GERMANY ...	13
TIME COOKING	4		

PART NAMES

OVEN

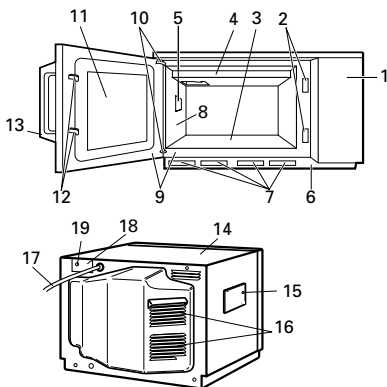

- 1 Control panel
- 2 Door lock openings
- 3 Ceramic floor
- 4 Splash cover
- 5 Oven lamp
- 6 Air intake filter
- 7 Air intake opening
- 8 Oven cavity
- 9 Door seals and sealing surfaces
- 10 Door hinges
- 11 Door
- 12 Safety door latches
- 13 Door open handle
- 14 Outer cabinet
- 15 Oven lamp access cover
- 16 Ventilation openings
- 17 Power supply cord
- 18 Mounting plate
- 19 Screw for mounting plate

CONTROL PANEL

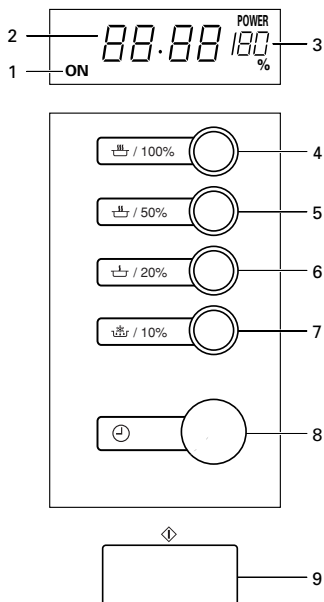

DISPLAY AND INDICATORS

Check indicators after the oven starts to confirm the oven is operating as desired.

- 1 Cook indicator
This indicator shows cooking in progress.
- 2 Digital display
- 3 Microwave power level indicator

OPERATING BUTTONS

- 4 Power 100%
 - 5 Power 50%
 - 6 Power 20%
 - 7 Power 10%
- } MICROWAVE POWER LEVEL button
- 8 ELECTRONIC TIMER
Rotate the knob to enter cooking time.
 - 9 START button

* The illustration of OPERATING BUTTONS is for R- 22AM/R- 23AM. Although the design for R- 25AM is slightly different, each button name and the function is same.

IMPORTANT SAFETY INSTRUCTIONS

IMPORTANT SAFETY INSTRUCTIONS: READ CAREFULLY AND KEEP FOR FUTURE REFERENCE

1. This appliance is intended to be used by expert or trained user in shops, in light industry and on farms, or for commercial use by lay persons.
2. This oven is designed to be used on a countertop only. It is not designed to be built into a kitchen unit. Do not place the oven in a cabinet.
3. The electrical outlet must be readily accessible so that the unit can be unplugged easily in an emergency.

If smoke or burn is observed: Keep the oven door closed and switch off the power by disconnecting the plug from the socket in order to stifle any flames. Failure to follow this procedure may result in fire and oven damage.

4. Ensure there is a minimum of free space above the oven of 25 cm.
5. This appliance is not intended for use by persons (including children) with reduced physical, sensory or mental capabilities, or lack of experience and knowledge, unless they have been given supervision or instruction concerning use of the appliance by a person responsible for their safety.
6. Children should be supervised to ensure that they do not play with the appliance.
7. **WARNING:** Only allow children to use the oven without supervision when adequate instructions have been given so that the child is able to use the oven in a safe way and understands the hazards of improper use.
8. **WARNING:** If the door or door seals are damaged, the oven must not be operated until it has been repaired by a competent person.
9. **WARNING:** Never adjust, repair or modify the oven yourself. It is hazardous for anyone other than a competent person to carry out any service or repair operation which involves the removal of a cover which gives protection against exposure to microwave energy.
10. If the power supply cord of this appliance is damaged, it must be replaced by an authorised SHARP service agent in order to avoid a hazard.
11. **WARNING:** Liquids and other foods must not be heated in sealed containers since they are liable to explode.
12. **WARNING:** Microwave heating of beverages can result in delayed eruptive boiling, therefore care must be taken when handling the container.
13. Do not cook eggs in their shells, and whole hard boiled eggs should not be heated in microwave ovens since they may explode even after microwave cooking has ended. To cook or reheat eggs which have not been scrambled or mixed, pierce the yolks and the whites, or the eggs may explode. Shell and slice hard boiled eggs before reheating them in the microwave oven.
14. Utensils should be checked to ensure that they are suitable for use in the oven. See "GUIDE" on page 8. Use only microwave safe containers and utensils.
15. **WARNING:** The contents of feeding bottles and baby food jars must be stirred or shaken and the temperature checked before consumption, in order to avoid burns.
16. When heating food in plastic or paper containers, keep an eye on the oven due to the possibility of ignition.
17. Clean the oven at regular intervals and remove any food deposits.
18. Failure to maintain the oven in a clean condition could lead to deterioration of the surface that could adversely affect the life of the appliance and possibly result in a hazardous situation.
19. See instructions for cleaning door seals, cavities and adjacent parts on page 6.
20. The oven should not be cleaned with a water jet.

To avoid the danger of fire

1. **The microwave ovens should not be left unattended during operation. Power levels that are too high or cooking times that are too long may overheat foods resulting in a fire.**
2. The AC power supply must be 230V, 50Hz, with a minimum 16A distribution line fuse, or a minimum 16A distribution circuit breaker. In using two ovens, each oven must be secured with a 16A distribution line fuse or a distribution circuit breaker.
3. A separate circuit serving only this appliance should be provided.
4. Do not place the oven in areas where heat is generated. For example, close to a conventional oven.
5. Do not install the oven in an area of high humidity or where moisture may collect.
6. Do not store or use the oven outdoors.
7. **Clean the splash cover and the oven cavity after use. These must be dry and free from grease. Built-up grease may overheat and begin to smoke or catch fire.**
8. Do not place flammable materials near the oven or ventilation openings.
9. Do not block the ventilation openings.
10. Remove all metallic seals, wire twists, etc., from food and food packages. Arcing on metallic surfaces may cause a fire.
11. Do not use the microwave oven to fry with oil or heat oil for deep frying. The temperature can not be controlled and the oil catch fire.
12. To make popcorn use only special microwave makers.
13. Do not store food or any other items inside the oven.
14. Check the settings after you start the oven to ensure the oven is operating as desired.

15. To avoid overheating and fire, special care must be taken when cooking or reheating foods with a high sugar or fat content, for example, Sausage rolls, Pies or Christmas pudding.
16. See the corresponding hints in this operation manual and in the attached cookery book section.

To avoid the possibility of injury

WARNING:

1. Do not operate the oven if it is damaged or malfunctioning. Check the following before use:
 - a) The door; make sure the door closes properly and ensure it is not misaligned or warped.
 - b) The hinges and safety door latches; check to make sure they are not broken or loose.
 - c) The door seals and sealing surfaces; ensure that they have not been damaged.
 - d) Inside the oven cavity or on the door; make sure there are no dents.
 - e) The power supply cord and plug; ensure that they are not damaged.
2. Do not operate the oven with the door open or alter the safety door latches in any way.
3. Do not operate the oven if there is an object between the door seals and sealing surfaces.
4. Do not allow grease or dirt to build up on the door seals and adjacent parts. Follow instructions for "Care and Cleaning", Page 6
5. Individuals with **PACEMAKERS** should check with their doctor or the manufacturer of the pacemaker for precautions regarding microwave ovens.

To avoid the possibility of electric shock

1. Under no circumstances should you remove the outer cabinet.
2. Never spill or insert any objects into the door lock openings or ventilation openings. In the event of a spill, turn off and unplug the oven immediately, and call a SHARP service agent.
3. Do not immerse the power supply cord or plug in water or any other liquid.
4. Do not let the power supply cord hang over the edge of a table or work surfaces.
5. Keep the power supply cord away from heated surfaces, particularly the back of the oven.
6. Unplug the oven before replacing the oven lamp.

To avoid the possibility of explosion and sudden boiling

1. Never use sealed containers. Remove seals and lids before use. Sealed containers can explode due to a build up of pressure even after the oven has been turned off.
2. Take care when microwaving liquids. Use a wide-mouthed container to allow bubbles to escape.

Never heat liquids in narrow necked containers such as baby bottles, as this may result in the contents erupting from the container when heated and cause burns.

To prevent sudden eruption of boiling liquid and possible scalding:

1. Do not use excessive amount of time (See page 9,10).
2. Stir liquid prior to heating/reheating.
3. It is advisable to insert a glass rod or similar utensil (not metal) into the liquid whilst reheating.
4. Let liquid stand for at least 20 seconds in the oven at the end of cooking time to prevent delayed eruptive boiling.
3. Pierce the skin on such foods as potatoes, sausages and fruit before cooking, or they may explode.

To avoid the possibility of burns

1. Use pot holders or oven gloves when removing food from the oven to prevent burns.

2. Always open containers, popcorn makers, oven cooking bags, etc., away from the face and hands to avoid steam burns and eruption of boiling.

3. To avoid burns, always test food temperature and stir before serving and pay special attention to the temperature of food and drink given to babies, children or the elderly.

Temperature of the container is not a true indication of the temperature of the food or drink; always check the food temperature.

4. Always stand back from the oven door when opening it to avoid burns from escaping steam and heat.
5. Slice stuffed baked foods after heating to release steam and avoid burns.
6. Keep children away from the door to prevent them burning themselves.
7. Do not touch the back of the oven because it will become hot.

To avoid misuse by children

1. Do not lean or swing on the oven door. Do not play with the oven or use it as a toy.
2. Children should be taught all important safety instructions: use of pot holders, careful removal of food coverings; paying special attention to packaging (e.g. self-heating materials) designed to make food crisp, as they may be extra hot.

Other warnings

1. Never modify the oven in any way.
2. Do not move the oven while it is in operation.
3. This oven is for food preparation only and may only be used for cooking food. It is not suitable for laboratory use.

To promote trouble free use of your oven and avoid damage.

1. Never operate the oven when it is empty. Doing so may damage the oven.
2. When using a browning dish or self-heating material, always place a heat-resistant insulator such as a porcelain plate under it to prevent damage to the ceramic floor due to heat stress. The preheating time specified in the dishes instructions must not be exceeded.
3. Do not use metal utensils, which reflect microwaves and may cause electrical arcing. Do not put cans in the oven.
4. Do not place anything on the outer cabinet during operation.
5. Do not use the oven near a steamer or a fryer.

NOTE

1. If you are unsure how to connect your oven, please consult an authorized qualified electrician.
2. Neither the manufacture nor the dealer can accept any liability for damage to the oven or personal

injury resulting from failure to observe the correct electrical connection procedure.

3. Water vapour or drops may occasionally form on the oven walls or around the door seals and sealing surfaces. This is a normal occurrence and is not an indication of microwave leakage or a malfunction.

INSTALLATION INSTRUCTIONS

WARNING : Always keep the caution sheet (SPECIAL INSTRUCTIONS AND WARNINGS) close to the oven for your reference.

- 1) Remove all packing materials from the inside of the oven cavity. Remove all the blue protective film from the outside of the oven.
- 2) Check the oven carefully for any signs of damage.
- 3) Place the oven on a flat, level surface strong enough to support the oven's weight plus the heaviest item likely to be cooked.
Do not place this oven in a position which is not easily accessible. To position the oven too high can be dangerous because food can not be removed safely.
- 4) Ensure there is a minimum free space above the oven of 25 cm.

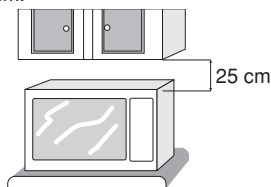

- 5) Securely connect the plug of the oven to a standard earthed (grounded) household electrical outlet.
- 6) Two same oven models can be installed together by placing one on top of another. Follow these instructions.

- 6-1) Place the oven A and position the oven B on top of the oven A as shown in the figure A.
- 6-2) Remove the single screw (a) holding the mounting plate A to the rear cabinet of the oven A. And remove the mounting plate A.
- 6-3) Remove the single screw (b) from the rear cabinet of the oven B, as shown in the figure A.
- 6-4) Reinstall the mounting plate A to the rear cabinet of the oven B with the single screw (b) removed, as shown in the figure A.

- 6-5) Hold the mounting plate A to the rear cabinet of the oven A with the single screw (a), as shown in the figure A.
- 6-6) Remove the screw (a) holding the mounting plate B to the rear cabinet of the oven B. And remove the mounting plate B from the oven B. See the figure A.
- 6-7) Install the screw (a) to its position again.
- 6-8) Remove the screw (c) from the oven A.
- 6-9) Remove the screw (d) from the oven B.
- 6-10) Turn the removed mounting plate B over and then using the removed screw (c) and (d), attach the mounting plate B, as shown in the figure A.

WARNING:

In case where two ovens are installed together by placing one on top of another.

- 1) Use the two mounting plates for fixing the two ovens.
- 2) Make sure that the power supply cord is not caught between the two ovens.
- 3) Do not install more than one oven on top of another.
- 4) Do not lose the removed screws.

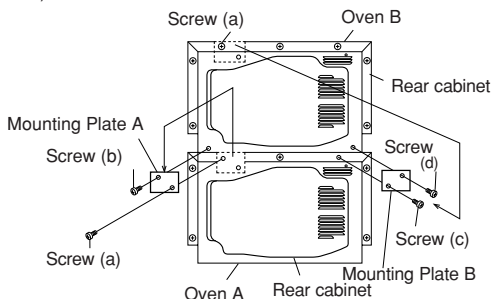

Figure A: How to fix two ovens

ACCESSORIES

Check to make sure the following accessory is provided:

- Operation manual
- Caution Sheet (SPECIAL INSTRUCTIONS AND WARNINGS : part code TCAUHA429WRRZ, TCAUHA430WRRZ and TCAUHA445WRRZ)

NOTE:

- When you order accessories, please mention the two items : part name and model name to your dealer or SHARP authorized service agent.
- The model name is printed on the door of the microwave oven.

SHORT DESCRIPTION OF FEATURES

Time setting key : time setting with different time intervals in both directions.

Time cooking : for individual cooking and defrosting of different types of food by setting of time and power.

Repeat cook : after manual operation it is possible to use same cooking time and power level again just by pressing microwave power level button and then start button.

Error message : Mistakes in operation or technical problems are displayed with an Error code.

BEFORE OPERATION

* Before operating your new oven, make sure you read and understand this operation manual completely.

- 1) Plug in the oven.
*The digital display will then show .
- 2) You can input the buttons and electronic timer only when the door is closed.
- 3) Oven lamp and fan motor work for 1 minute whenever the door is opened or after cooking.
- 4) The programme is canceled when any buttons or

electronic timer are not touched for more than 3 minutes during programming.





- 5)  will appear on the display after the timer reaches zero. It will disappear when the oven door is opened.
- 6) To cancel a programme during cooking, open and close the door, and then open the door again.

TIME COOKING

Your oven can be programmed for max. 30 minutes and has 4 preset power levels.

NOTE for R-25AM:

The maximum cooking time for 100% or 50% is 15 minutes. If the time you set exceeds a maximum time, the display will show "EE 9".

LEVELS	MICROWAVE POWER	R-22AM	WATT R-23AM	R-25AM
	100%	1500	1800	2100
	50%	750	900	1050
	20%	300	360	420
	10%	150	180	210

Example: Suppose you want to cook for 2 minutes and 30 seconds at 50%.

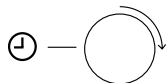

Rotate the knob clockwise to the desired cooking time (2 min. and 30 sec.).



Choose desired power level (50%).

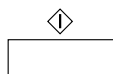

Start to cook.

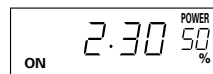

Check the display.

NOTE:

1. It is not necessary to touch MICROWAVE POWER LEVEL button for 100 %.
2. During the cooking, the oven will stop when the door is opened. To restart the cooking, close the door and press the START button. If any of buttons or electric timer is not touched within 1 minute after closing the door, the programme will be cancelled.
3. The remaining cooking time is canceled when the door is closed and opened during stop mode.
4. If you rotate the knob counterclockwise, the cooking time will decrease from 30 minutes by degrees.

As the time to be set increases, the timer steps in larger increments (units), as shown on the table below. Ex. for R-22AM/23AM: If a time between 0 - 60 seconds is entered, the cooking time will increase in 2 second steps, whereas if the time is between 10 - 30 minutes each step will be a 30 second increment.

COOKING TIME SETTING UNIT

(For R-22AM/23AM)

COOK TIME	UNIT
0 - 60 seconds	2 seconds
60 seconds - 3 minutes	5 seconds
3 - 10 minutes	10 seconds
10 - 30 minutes	30 seconds

(For R-25AM)

COOK TIME	UNIT
0 - 20 seconds	2 seconds
20 seconds - 1 minute	5 seconds
1 - 6 minutes	10 seconds
6 - 15 minutes	30 seconds
15 - 30 minutes	1 minute

OTHER CONVENIENT FEATURES

REPEAT COOK

Your oven can memorize the last cooking time in each power level. If you use this function, you have no need to enter the cooking time.

Example: Suppose you want to use this function at 100%. (The last cooking time is 10 min.).

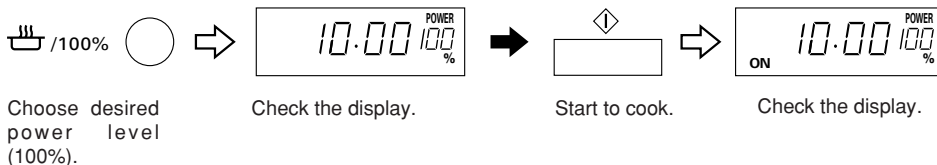

INFORMATION WITH ERROR MESSAGES

If ERROR messages are displayed, follow the below instructions.

ERROR MESSAGES

EE1,EE2,EE3, EE6,EE10,EE16	Please contact your dealer or an authorized Sharp service agent because the oven must be out of order.
EE8,EE0 (For R-22AM/23AM)	
EE19 (For R-25AM)	
EE7	Exhaust air temperature is too high. Checking that nothing is blocking the ventilation openings or that room temperature is very hot or that oven cavity is empty during operation. Correct and try again after a few minutes.
EE17	Magnetron temperature is too high, open and close the door twice, and then try again after a few minutes.
EE9 (For R-25AM)	The time you set exceeds a maximum time. Open and close the door twice, and enter appropriate time.

CARE AND CLEANING

CLEAN THE OVEN AT REGULAR INTERVALS AND REMOVE ANY FOOD DEPOSITS- Keep the oven clean, or the oven could lead to deterioration of the surface. This could adversely affect the life of the appliance and possibly result in a hazardous situation.

VERY IMPORTANT CAUTIONS:

- DO NOT OPERATE THE OVEN WITHOUT THE SPLASH COVER IN PLACE.
- DO NOT REMOVE THE SPLASH COVER UNLESS THE POWER CORD IS REMOVED FROM THE OUTLET BECAUSE THE ROTARY ANTENNA, WHICH IS LOCATED ON THE CEILING, OPERATES FOR 1 MINUTE AFTER THE DOOR IS OPENED AND INJURY COULD OCCUR.
- DO NOT USE COMMERCIAL OVEN CLEANERS, ABRASIVE, HARSH CLEANERS OR SCOURING PADS ON ANY PART OF YOUR MICROWAVE OVEN.
- DO NOT SPRINKLE WATER ONTO THE OVEN DIRECTLY. IT MAY CAUSE ELECTRIC SHOCK, LEAKAGE OF ELECTRICITY OR DAMAGE OF THE OVEN.
- THE OVEN SHOULD NOT BE CLEANED WITH A WATER JET.

Oven Exterior

The outside of your oven can be cleaned easily with mild soap and water. Make sure that the soap is wiped off with a moist cloth, and dry the exterior with a soft towel.

Control Panel

Open the door before cleaning to inactivate the control panel buttons or electronic timer. Care should be taken in cleaning the control panel. Using a cloth dampened with water only, gently wipe the panel until it becomes clean. Avoid the use of excess water. Do not use any sort of chemical or abrasive cleaner.

Oven Interior

- 1) For easy cleaning, wipe any spatters or spills with a soft damp cloth or sponge at the end of each day for hygienic reasons. For heavier spills, use mild soap and wipe several times with a damp cloth until all residues are removed. Built-up splashes may overheat and begin to smoke or catch fire, and cause arcing.
- 2) Keep the ceramic floor clean at all times. If you leave grease or fat in the cavity, it may overheat, smoke or even catch fire when next using the oven.

CAUTION:

DO NOT REMOVE THE CERAMIC FLOOR FROM THE OVEN.

- 3) Make sure that mild soap or water does not penetrate through the small vents in the walls which may cause damage to the oven.
- 4) Do not use spray type cleaners on the oven interior.

Splash cover

AT LEAST ONCE A WEEK, REMOVE THE SPLASH COVER AND WASH BOTH SIDES OF IT IN A MILD DETERGENT SOLUTION. BUILT-UP GREASE MAY OVERHEAT AND BEGIN TO SMOKE. AND OVERHEATED GREASE MAY BURN THE SPLASH COVER. THE SPLASH COVER IS LOCATED IN THE TOP OF THE OVEN AND MAY EASILY BE REMOVED. REMEMBER TO UNPLUG THE POWER CORD.

Removal:

1. Remove two thumb screws (A) as shown in Fig. 1.
2. Remove the splash cover from the oven.

Reinstall:

1. Insert two projections of the cover (B) into the holes of the oven cavity backplate as shown in Fig. 2.
2. Secure the cover to the oven ceiling with two thumb screws (A) as shown in Fig. 1.

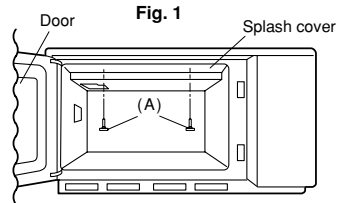

Fig. 1

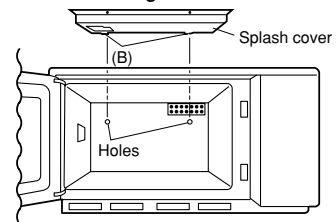
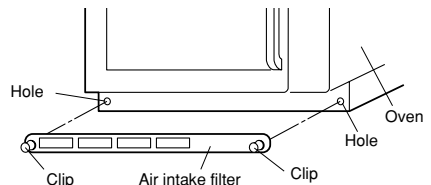

Fig. 2

Door

To remove all trace of dirt, regularly clean both sides of the door, the door seals and adjacent parts with a soft, damp cloth. Do not use abrasive cleaner.

Air intake filter



Keep clean the air intake filter. To clean the air intake filter you have to pull the two clips on the filter and to remove the air intake filter. Wash the air intake filter in mild soapy water and dry with a soft cloth. After cleaning re-install the air intake filter to the oven. Clean the air intake filter once every two weeks.

CAUTION:

DO NOT OPERATE THE OVEN WITHOUT THE AIR INTAKE FILTER IN PLACE.

Oven lamp replacement

Unplug the oven before removing the oven lamp access cover, and replace the lamp (25W/240V). Make sure that the cover is secured to the oven cabinet after replacing the lamp.

SERVICE CALL CHECK

Please check the following before calling for service.

1. Power Supply

Check the power plug is properly connected to a suitable wall outlet.

Check the line fuse/circuit breaker is functioning properly.

2. When the door is opened.

A. Does the oven lamp light ?

YES _____ NO _____

B. Does the cooling fan work ?

YES _____ NO _____

(Put your hand over the rear ventilation opening.)

3. Place one cup of 150 ml water in the oven and close the door securely.

Programme the oven for one minute at 100% ().

And start the oven.

A. Does the cook indicator go on ?

YES _____ NO _____

B. At the end of this time, is the water warm ?

YES _____ NO _____

If "NO" is the answer to any of the above questions, call your dealer or an authorized SHARP Service Agent and report the results of your check.

GUIDE

USEFUL THINGS TO KNOW ABOUT MICROWAVES

Microwaves set the water molecules contained in the food vibrating. The resulting friction generates heat that can be used to defrost or cook the food.

Food



The microwaves are absorbed by the food

SUITABLE UTENSILS

Glass, Glass-ceramics and Porcelain

Heat-resistant utensils made of glass, glass-ceramic or porcelain are suitable. However, the utensils must not contain metals (e.g., lead crystal) or be metal-plated (e.g., gold rim, cobalt blue).

Glass, Porcelain, Ceramics Plastics, paper etc.

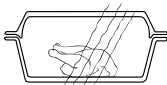

Microwaves pass through

Ceramics

are usually suitable but they must be enamelled. When using utensils that are not enamelled, moisture can be absorbed by the material and heat it up. This can cause the material to crack.

Plastics and Paper Dishes

Heat-resistant and microwave-proof plastic utensils or paper dishes are suitable for defrosting, heating and cooking. Please follow the manufacturer's instructions.

Microwave Plastic Wrap

or heat-resistant wrap is suitable for covering and wrapping food. Please follow the manufacturer's instructions.

Roasting Bags

can be used in microwave ovens. Do not close the bags with a metal clip because the clip may cause the bag film to melt. Close the bag with string and pierce it several times with a fork. Films that are not heat-resistant, e.g., films to retain product freshness are not recommended for use in microwave ovens.

Metals

should not, as a rule, be used in microwave ovens because microwaves cannot penetrate metals and reach the food inside.

There are, however, some exceptions: Small strips of aluminum foil can be used to cover parts to prevent them from defrosting or cooking too fast (e.g., chicken wings).

Metal

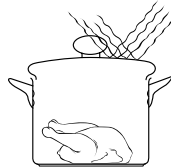

Microwaves are reflected

Small metal skewers and aluminum trays (of pre-packaged food) may be used. However, they must be small in proportion to the food. Aluminum containers, for example, must be filled to at least 2/3 to 3/4 with food. It is recommendable to transfer the food into microwave-safe containers.

When using aluminum trays or other metal utensils, they must be placed at least 2.0 cm away from the cavity walls. Otherwise the cavity walls may be damaged by sparking.

Do not use any utensils with metal-plating, metal parts or metal projections like screws, ribbons, or handles.

TESTING UTENSILS

Perform the following test if you are unsure whether a certain utensil is microwave-safe: Place the utensil into the oven, put a glass containing about 150 ml of water on or beside the utensil, and operate the microwave oven at 100% power for 1 to 2 minutes. If it is cool or luke-warm to the touch, the utensil is suitable for microwave use. Do not perform this test on plastic dishes because the plastic might melt.

INFORMATION ABOUT POWER LEVEL

100% power:

The high power is perfect for warming up or regenerating food. You can also use it to make food boil e.g. water and then cook further with lower power. (e.g. for rice or noodles)

50% power:

For longer cooking times and compact types of food.

20% power:

For considerate cooking and sensitive menus. Also after cooking to simmer or for noodles and rice.

10% power:

The low power level is mainly for defrosting. You can also use it for cooking of very sensitive menus like cheese sauce.

Basically it is recommendable to cover the food for cooking or reheating. Additionally you can sprinkle some water over the food (you can also use salted water or even bouillon).

The water steam keeps the food moist and it also helps to make the cooking faster.

COOKING CHART AND RECIPES

1500W	Menu	Init. Temp.	Microwave Power Levels	200g	400g	600g	Comment
DEFROST	Meat	-18°C	10%	approx. 5'20"	approx. 8'	approx. 12'	Turn over at 1/2 of total defrosting time. Standing time : about 10 mins.
	Poultry	-18°C	10%	approx. 5'20"	approx. 8'30"	approx. 13'	
	Fish	-18°C	10%	approx. 5'20"	approx. 8'30"	approx. 11'	
	Fruit	-18°C	10%	approx. 4'	approx. 7'30"	—	
	*Cake (no fruit or cheese)	-18°C	10%	approx. 1'40"	approx. 2'10"	approx. 2'40"	
	*Cream cake	-18°C	10%	approx. 1'30"	approx. 2'50"	—	
	Shrimps	-18°C	10%	approx. 5'	approx. 8'30"	approx. 12'	
	**Cold meat	-18°C	10%	approx. 4'	approx. 6'30"	approx. 9'	
	REHEAT	Soup, clear	5±2°C	100%	approx. 1'10"	approx. 2'10"	
Soup, cream		5±2°C	100%	approx. 1'20"	approx. 2'20"	approx. 3'20"	
Casseroles		5±2°C	100%	approx. 1'20"	approx. 2'20"	approx. 3'30"	
Supplements, Noodles		5±2°C	100%	approx. 1'10"	approx. 2'	approx. 2'50"	
Supplements, Rice		5±2°C	100%	approx. 1'10"	approx. 2'	approx. 2'50"	
Supplements, Potatoes		5±2°C	100%	approx. 1'10"	approx. 2'	approx. 3'	
Supplements, Vegetables		5±2°C	100%	approx. 1'10"	approx. 2'	approx. 2'50"	
Baked Beans		5±2°C	100%	approx. 1'20"	approx. 2'20"	—	
Goulash, Ragout		5±2°C	100%	approx. 1'30"	approx. 2'30"	approx. 3'30"	
*Meat (150g)		5±2°C	100%	approx. 1'	approx. 1'40"	—	
*Sausages (50g)		5±2°C	100%	approx. 20 sec.	approx. 30 sec.	approx. 50 sec.	
COOK	Supplements, Potatoes	20±2°C	100%	approx. 2'50"	approx. 5'30"	approx. 6'30"	Use casserole lid. Stir at 1/2 of total cooking time.
	Supplements, Vegetables	20±2°C	100%	approx. 3'20"	approx. 5'30"	approx. 7'30"	
1800W	Menu	Init. Temp.	Microwave Power Levels	200g	400g	600g	Comment
DEFROST	Meat	-18°C	10%	approx. 4'30"	approx. 6'30"	approx. 8'30"	Turn over at 1/2 of total defrosting time. Standing time : about 10 mins.
	Poultry	-18°C	10%	approx. 4'30"	approx. 6'30"	approx. 9'30"	
	Fish	-18°C	10%	approx. 4'30"	approx. 6'30"	approx. 8'30"	
	Fruit	-18°C	10%	approx. 2'50"	approx. 5'30"	—	
	*Cake (no fruit or cheese)	-18°C	10%	approx. 1'10"	approx. 1'50"	approx. 2'10"	
	*Cream cake	-18°C	10%	approx. 1'10"	approx. 2'10"	—	
	Shrimps	-18°C	10%	approx. 4'	approx. 6'30"	approx. 9'	
	**Cold meat	-18°C	10%	approx. 3'	approx. 5'30"	approx. 8'	
	REHEAT	Soup, clear	5±2°C	100%	approx. 1'	approx. 1'40"	
Soup, cream		5±2°C	100%	approx. 1'	approx. 2'	approx. 2'50"	
Casseroles		5±2°C	100%	approx. 1'10"	approx. 2'	approx. 2'50"	
Supplements, Noodles		5±2°C	100%	approx. 50 sec.	approx. 1'20"	approx. 2'20"	
Supplements, Rice		5±2°C	100%	approx. 50 sec.	approx. 1'30"	approx. 2'30"	
Supplements, Potatoes		5±2°C	100%	approx. 50 sec.	approx. 1'30"	approx. 2'30"	
Supplements, Vegetables		5±2°C	100%	approx. 50 sec.	approx. 1'50"	approx. 2'30"	
Baked Beans		5±2°C	100%	approx. 1'	approx. 2'	—	
Goulash, Ragout		5±2°C	100%	approx. 1'10"	approx. 2'10"	approx. 3'	
*Meat (150g)		5±2°C	100%	approx. 40 sec.	approx. 1'20"	—	
*Sausages (50g)		5±2°C	100%	approx. 15 sec.	25 sec.	35 sec.	
COOK	Supplements, Potatoes	20±2°C	100%	approx. 2'10"	approx. 4'40"	approx. 6'	Use casserole lid. Stir at 1/2 of total cooking time.
	Supplements, Vegetables	20±2°C	100%	approx. 2'50"	approx. 4'40"	approx. 6'30"	

*indications per pcs. (1,2,3 pcs.) not in gramm.

**Remove defrosted portions. Standing time : about 10 mins.

2100W	Menu	Init. Temp.	Microwave Power Levels	200g	400g	600g	Comment
DEFROST	Meat	-18°C	10%	approx. 4'	approx. 5'50"	approx. 8'30"	Turn over at 1/2 of total defrosting time. Standing time : about 10 mins.
	Poultry	-18°C	10%	approx. 4'20"	approx. 6'30"	approx. 9'30"	
	Fish	-18°C	10%	approx. 4'	approx. 5'30"	approx. 7'30"	
	Fruit	-18°C	10%	approx. 2'50"	approx. 5'20"	—	
	*Cake (no fruit or cheese)	-18°C	10%	approx. 1'	approx. 1'40"	approx. 2'	
	*Cream cake	-18°C	10%	approx. 1'25"	approx. 2'10"	—	
Shrimps	-18°C	10%	approx. 4'	approx. 6'30"	approx. 9'		
**Cold meat	-18°C	10%	approx. 3'	approx. 5'30"	approx. 8'		
REHEAT	Soup, clear	5±2°C	100%	approx. 50 sec.	approx. 1'30"	approx. 2'20"	Cover with microwave foil or lid. Stir well after reheating.
	Soup, cream	5±2°C	100%	approx. 1'	approx. 1'40"	approx. 2'40"	
	Casseroles	5±2°C	100%	approx. 1'	approx. 1'40"	approx. 2'40"	
	Supplements, Noodles	5±2°C	100%	approx. 40 sec.	approx. 1'10"	approx. 2'	
	Supplements, Rice	5±2°C	100%	approx. 40 sec.	approx. 1'20"	approx. 2'	
	Supplements, Potatoes	5±2°C	100%	approx. 40 sec.	approx. 1'30"	approx. 2'10"	
	Supplements, Vegetables	5±2°C	100%	approx. 50 sec.	approx. 1'30"	approx. 2'10"	
	Baked Beans	5±2°C	100%	approx. 55 sec.	approx. 1'50"	—	
	Goulash, Ragout	5±2°C	100%	approx. 1'	approx. 2'	approx. 2'50"	
	*Meat (150g)	5±2°C	100%	approx. 40 sec.	approx. 1'20"	—	
	*Sausages (50g)	5±2°C	100%	approx. 15 sec.	25 sec.	40 sec.	
COOK	Supplements, Potatoes	20±2°C	100%	approx. 2'	approx. 3'30"	approx. 5'	Use casserole lid. Stir at 1/2 of total cooking time.
	Supplements, Vegetables	20±2°C	100%	approx. 2'10"	approx. 3'50"	approx. 5'20"	

*indications per pcs. (1,2,3 pcs.) not in gramm.

**Remove defrosted portions. Standing time : about 10 mins.

1500W	Menu	Int. Temp.	Microwave Power Levels	1 pc	2 pcs
SPECIALS	Danish Pastrys	20±2°C	100%	approx. 8 sec.	—
	*Doughnuts/Berliner	20±2°C	100%	approx. 8 sec.	approx. 12 sec.
	*Boucheés à la reine	20±2°C	100%	approx. 14 sec.	approx. 20 sec.
	*Burger	5±2°C	100%	approx. 1'	1'40"
	*Cheeseburger	5±2°C	50%	approx. 1'	1'50"
	Toast and Bacon(40g)	20±2°C	100%	approx. 14 sec.	—
	Scrambled Eggs and Bacon(140g)	5±2°C	100%	approx. 40 sec.	—

1800W	Menu	Int. Temp.	Microwave Power Levels	1 pc	2 pcs
SPECIALS	Danish Pastrys	20±2°C	100%	approx. 6 sec.	—
	*Doughnuts/Berliner	20±2°C	100%	approx. 5 sec.	approx. 8 sec.
	*Boucheés à la reine	20±2°C	100%	approx. 10 sec.	approx. 15 sec.
	*Burger	5±2°C	100%	40 sec.	1'20"
	*Cheeseburger	5±2°C	50%	50 sec.	1'30"
	Toast and Bacon(40g)	20±2°C	100%	10 sec.	—
	Scrambled Eggs and Bacon(140g)	5±2°C	100%	35 sec.	—

2100W	Menu	Int. Temp.	Microwave Power Levels	1 pc	2 pcs
SPECIALS	Danish Pastrys	20±2°C	100%	approx. 6 sec.	—
	*Doughnuts/Berliner	20±2°C	100%	approx. 5 sec.	approx. 8 sec.
	*Boucheés à la reine	20±2°C	100%	approx. 10 sec.	approx. 15 sec.
	*Burger	5±2°C	100%	35 sec.	1'10"
	*Cheeseburger	5±2°C	50%	50 sec.	1'40"
	Toast and Bacon(40g)	20±2°C	100%	10 sec.	—
	Scrambled Eggs and Bacon(140g)	5±2°C	100%	40 sec.	—

*indications per pcs. (1,2,3 pcs.) not in gramm.

Recipes

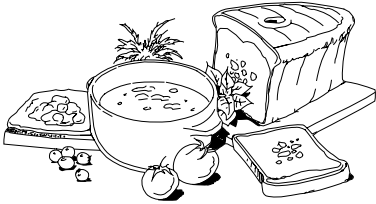

Omelette

Sprinkle a normal plate with fat. Beat three eggs with some salt and pepper. Pour the eggs on the plate and cook for ca. 1 min. 20 sec./50 sec./45 sec. Add any filling (2 tbsp.) you want (ragout, vegetables) and cook again for ca. 20 sec./10 sec./10 sec.

Scrambled Eggs

Mix two eggs with salt, pepper and some milk. Cook for approx. 1 min. 10 sec./45 sec./45 sec., three times stirring within total cooking time.

Hint: The first time refers to 1500 Watts, the second time to 1800 Watts, and the third time to 2100 Watts.
All recipes are cooked with 100 % microwave power.



Bacon

Place 2 thin slices of bacon between paper towels and cook. approx. 30 sec./20 sec./15 sec.

Toast Hawaii

Prepare toasts and spread with butter. Place one slice of ham, pineapple and cheeses on a plate and cook for approx. 25 sec./20 sec./20 sec. After cooking place on the prepared toast.

Hot chocolate with cream

Pour 150 ml milk in a big cup. Add 30 g black chocolate (pieces). Stir and cook for 1 min./50 sec./40 sec. Stir again once in between. Add some stirred cream and serve with some chocolate powder on top.



SPECIFICATIONS

AC Line Voltage	230V, 50Hz, single phase
Distribution line fuse/circuit breaker	16A (time lag)
AC Power Required	R-22AM : 2.4 kW R-23AM : 2.9 kW R-25AM : 3.15 kW
Output Power	R-22AM : 1500 W (IEC60705) R-23AM : 1800 W (IEC60705) R-25AM : 2100 W (IEC60705)
Microwave Frequency	2450 MHz *(Group 2/Class B)
Sound level	less than 70dB (A)
Outside Dimensions	510mm (W) x 335mm (H) x 470mm (D) (Single oven) 510mm (W) x 670mm (H) x 470mm (D) (Two ovens)
Cavity Dimensions	330mm (W) x 180mm (H) x 330mm (D)
Oven Capacity	20 litres
Cooking Uniformity	Rotary antenna system
Weight	Approx. 33 kg

* This Product fulfils the requirement of the European standard EN55011. In conformity with this standard, this product is classified as group 2 class B equipment. Group 2 means that the equipment intentionally generates radio-frequency energy in the form of electromagnetic radiation for heating treatment of food. Class B equipment means that the equipment suitable to be used in domestic establishments. (This product is designed for commercial application only and as such it falls outside the scope of Regulation (EC) 1275/2008 implementing EU Directive 2005/32/EC on eco-design requirements for standby and off mode electric power consumption. Sharp do not recommend the product for domestic application and will not accept any liability for such use.)

• SEULEMENT VALIDE POUR L'ALLEMAGNE ET L'AUTRICHE • SLECHTS GELDIG VOOR DUITSLAND EN OOSTENRIJK •
• SOLTANTO VALIDO PER LA GERMANIA E L'AUSTRIA • SOLAMENTE VÁLIDO PARA ALEMANIA Y AUSTRIA •

• Bei Vorliegen eines Produktmangels können Sie sich zwecks Reparaturabwicklung im Vor-Ort-Service bei Ihnen, direkt an den KUNDEN-SERVICE wenden.

DER SHARP KUNDEN-SERVICE



Sie erreichen die Service-Hotline:
montags bis freitags zwischen 8 und 18 Uhr
in Österreich: **0820 - 500 820** (€ 0,145/Min.)
in Deutschland: **01806 774277**
(0,20 € je Anruf aus dem deutschen Festnetz,
und maximal 0,60 € je Anruf aus dem deutschen Mobilfunknetz)

Garantie mit Quick 48 Vor-Ort-Service

Gilt für Deutschland und Österreich

Gastronomie Profi - Mikrowellengeräte

Sehr geehrter Sharp Kunde,

Ihr Profi-Mikrowellengerät wurde sorgfältig hergestellt und dessen Funktionsfähigkeit einer Endkontrolle unterzogen.

Umfang der Garantie:

Sollte Ihr Profi-Mikrowellengerät trotz sorgfältiger Herstellung und Endkontrolle einen Mangel aufweisen, können Sie innerhalb der Garantiezeit zusätzlich zu den gesetzlichen Sachmängelansprüchen, die Ihnen gegen Ihren Verkäufer zustehen, Garantieleistungen gegen Sharp Electronics (Europe) GmbH in Anspruch nehmen. Diese stehen Ihnen zu, wenn ein herstellungsbedingter Material- und/oder Verarbeitungsmangel (nachfolgend "Mangel") bei dem Profi-Mikrowellengerät oder Teilen davon - mit Ausnahme der Garraum-Glühlampe - innerhalb von 24 Monaten auftritt. Die Garantie umfasst nicht Mängel, die durch unsachgemäße Behandlung, Bedienungsfehler oder durch Fremdeinwirkung entstanden sind. Transportschäden bei Neugeräten müssen Sie bei Ihrem Verkäufer geltend machen. Die Garantiefrist von 24 Monaten beginnt mit dem Tag, an dem Sie das fabriekneue Gerät von einem Händler gekauft haben. Die Erbringung von Garantieleistungen verlängert nicht die Garantiezeit.

Garantieleistungen:

Sharp Electronics (Europe) GmbH erfüllt seine Garantieverpflichtungen für Mängel durch kostenlose Reparatur durch einen **Quick 48 Stunden Vor-Ort-Service**. Etwa anfallende Transportkosten innerhalb Deutschlands und Österreich übernehmen wir.

Im Quick 48 Stunden Vor-Ort-Service werden alle Reklamationen, die von montags und freitags zwischen 8:00 und 18:00 Uhr beim Quick 48 Deutschland, **Tel.: 01806 774277*** (* 0,20 € je Anruf aus dem deutschen Festnetz, und maximal 0,60 € je Anruf aus dem deutschen Mobilfunknetz) und in Österreich **Tel.: 0820 / 500 820**** (€0,145/Min) eingehen, ab dem darauffolgenden Werktag gerechnet, im Regelfall innerhalb 48 Stunden bei Ihnen im Vor-Ort-Service repariert.

Geltendmachung der Garantie:

Der Mangel des Gerätes muss innerhalb der Garantiefrist unter Angabe des Kaufdatums, der Modellbezeichnung und der Seriennummer des Gerätes unter den oben aufgeführten Telefonnummern geltend gemacht werden. Bei der Vor-Ort-Reparatur ist dann der Kaufbeleg, aus dem sich das Kaufdatum, die Modellbezeichnung und die Seriennummer des Gerätes ergibt, vorzulegen.

Selbstverständlich können Sie unseren QUICK 48 Stunden Vor-Ort-Service für Profi-Mikrowellengeräte auch nach Ablauf der Verjährungsfristen für Sachmängel-/Garantiefristen in Anspruch nehmen, dann jedoch gegen Aufwandsberechnung des jeweiligen Kundendienstes.

Garantiegeber: SHARP Electronics GmbH, SonninstraÙe 3, 20097 Hamburg
www.sharp.de

GB

Manufacturer: SHARP Corporation
22-22, Nagaike-cho, Abeno-ku, Osaka 545-8522, Japan
Authorised Representative: SHARP Electronics Europe Ltd.
4 Furzeground Way, Stockley Park, Uxbridge, Middlesex, UB11 1EZ, UK

